

結晶粒の小さい材料の極点図高速測定

X線照射領域1mm以下でもハードウェアの最大スピードで測定可能
1極点図20分以内で測定可能

照射エリアを制限するDSスリットを1deg→1/21degに変えても
ほぼ同一の極点図が得られます。

補正量の大きい極点図の外側を測定しなければ更に短時間で測定可能

ADC法のODF解析を行うのであれば、極点図3面の必要もありません。
(更に短時間で測定が可能になります。)

2012年05月18日マトメ

HelperTex Office

プロフィール測定

40kV-40mA NiFilter 2枚

DS: 1 deg. (入射高さ 10mm) SS: 1 deg. RS: 0.3mm

測定間隔 0.02deg Scanspeed 5deg/min(FT=0.24sec)

Schulzスリットなし、受光側高さ制限 opem

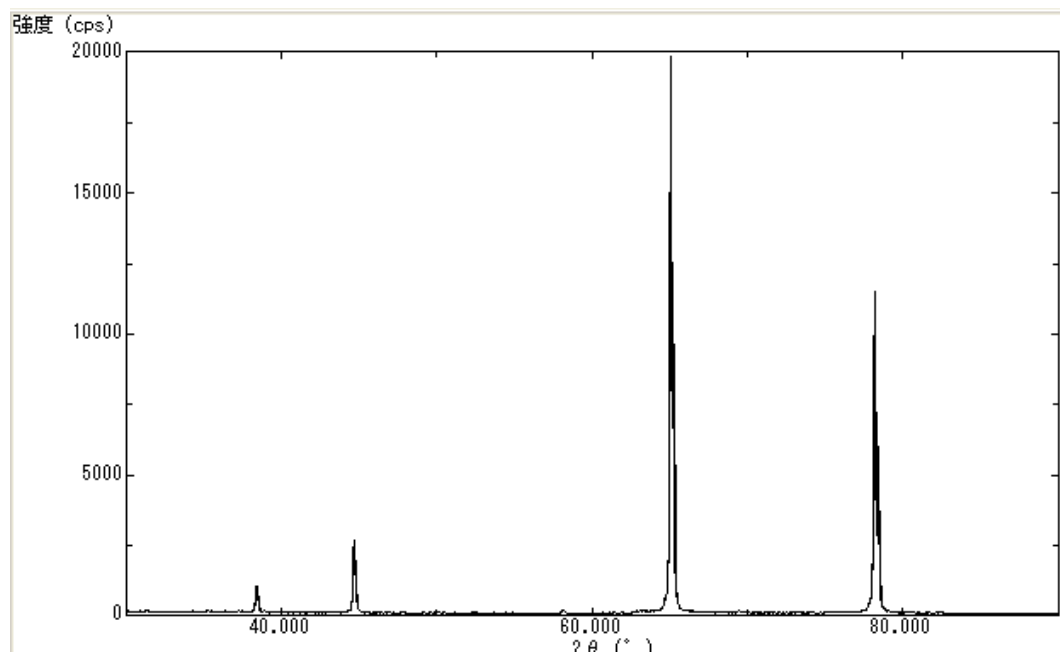

(220) のロッキングカーブ

40kV-40mA NiFilter 2枚

DS: 1/2 deg. (入射高さ 2mm) SS: open RS: open

測定間隔 0.02deg 測定 2θ 角度 65.06deg FT=2sec

Schulzスリット: 1mm 受光側高さ制限 10mm

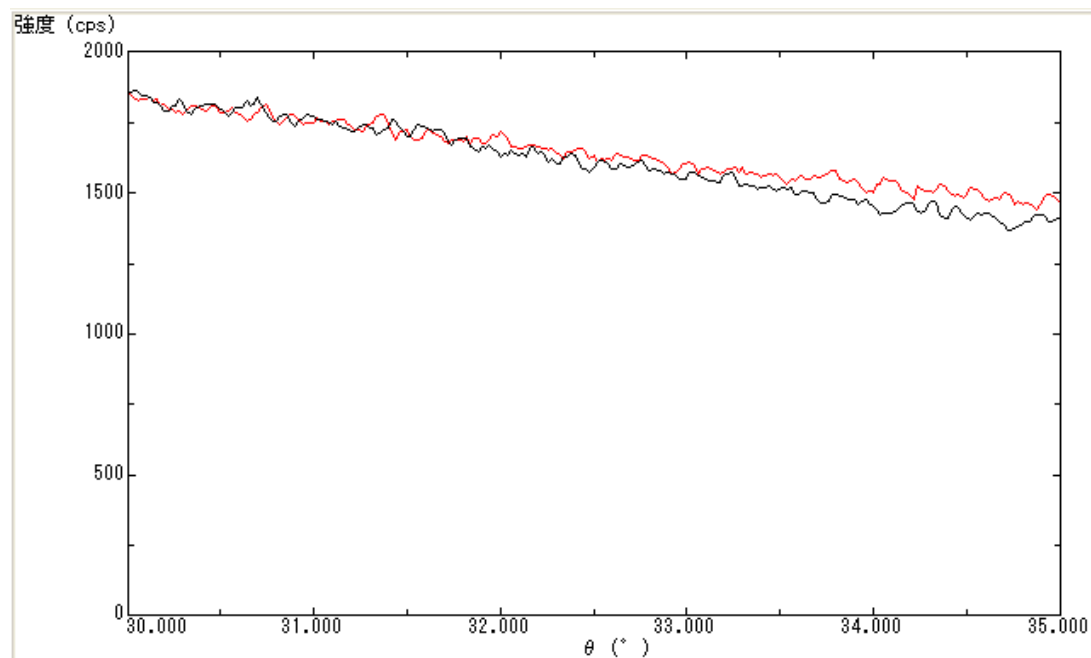

No.	ファイル名	フォルダ名	コメント	日付
1	<input checked="" type="checkbox"/> schultz-rocking-GOF			12/05/17
2	<input checked="" type="checkbox"/> schultz-rocking-GON			12/05/17

γ 揺動なしでも測定可能試料である

DSスリットの広がりによる試料位置における照射エリア

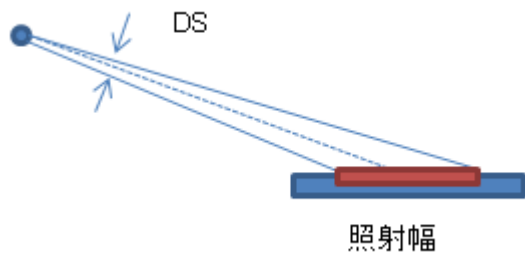

X線照射エリア

	垂直入射(mm)	{111} mm	{200} mm	{220} mm	{311} mm	
DS発散角度	2θ 角度	90	38.47	44.72	65.09	78.23
1.0deg	3.23	9.80	8.49	6.00	5.12	
1/2deg	1.61	4.90	4.24	3.00	2.56	
1/4deg	0.81	2.45	2.12	1.50	1.28	
1/6deg	0.54	1.63	1.41	1.00	0.85	
1/9deg	0.36	1.09	0.94	0.67	0.57	
1/12deg	0.27	0.82	0.71	0.50	0.43	
1/15deg	0.22	0.65	0.57	0.40	0.34	
1/18deg	0.18	0.54	0.47	0.33	0.28	
1/21deg	0.15	0.47	0.40	0.29	0.24	

極点測定

極点測定条件

40kV-40mA Ni Filter 2枚

DS : 各種 (入射高さ2mm) SS : 7mm RS : 7mm

α、β測定間隔5deg 測定βスピード:600deg/min

Schulzスリット : 1mm 受光側高さ制限10mm

測定結果、Max強度比較

β scan speed 600deg/minにおける最大強度

	{111} mm	{200} mm	{220} mm	{311} mm
DS発散角度	38.47deg	44.72deg	65.09deg	78.23deg
1.0deg	49,400	110,046	13,160	4,338
1/2deg	24,948	5,324	6,670	2,290
1/4deg	10,754	3,012	3,546	1,166
1/6deg	6,460	2,014	2,034	762
1/9deg	3,964	1,274	1,354	606
1/12deg	3,032	1,072	1,044	340
1/15deg	2,448	816	832	334
1/18deg	1,982	692	682	284
1/21deg	1,556	500	574	214

測定時間

111.raw	28 KB	生データ	2012/05/17 14:31
200.raw	28 KB	生データ	2012/05/17 14:49
220.raw	28 KB	生データ	2012/05/17 15:07
311.raw	28 KB	生データ	2012/05/17 15:26

バックグラウンド測定を行っている為に極点図毎に変化するが

3極点図測定で57分(1極点図で20分弱で測定可能)

データ処理結果（バックグラウンド除去、defocus 補正、平滑化 1 - 5、強度の規格化）

BD,defocus,SM1-5,規格化密度

	{111} mm	{200} mm	{220} mm	{311} mm
DS 発散角度	38.47deg	44.72deg	65.09deg	78.23deg
1.0deg	12.54	5.21	9.14	3.03
1/2deg	12.83	5.38	8.98	3.16
1/4deg	11.11	5.74	9.27	3.18
1/6deg	10.33	5.66	8.48	3.21
1/9deg	9.54	5.92	8.83	3.78
1/12deg	9.37	6.00	8.58	3.57
1/15deg	10.31	5.94	8.81	3.64
1/18deg	10.06	5.83	8.59	3.48
1/21deg	10.07	5.60	8.99	3.57

ODF 処理

Lattice constant

Material: Aluminum.txt

Structure Code(Symmetries after Schoenfiles): 7 - 0 (cubic)

a: 1.0 <=b: 1.0 <=c: 1.0 alfa: 90.0 beta: 90.0 gamm: 90.0

Initialize

Start

getHKL<-Filename

AllFileSelect

PF Data

SelectFile(TXT(b,intens),TXT2(a,b,intens.))	h,k,l	2Theta	Alfa Area	AlfaS	AlfaE	Select
111_chB00D3A15S_2.TXT	1,1,1	0.0	0.0->75.0	0.0	75.0	<input checked="" type="checkbox"/>
200_chB00D3A15S_2.TXT	2,0,0	0.0	0.0->75.0	0.0	75.0	<input checked="" type="checkbox"/>
220_chB00D3A15S_2.TXT	2,2,0	0.0	0.0->75.0	0.0	75.0	<input checked="" type="checkbox"/>
311_chB00D3A15S_2.TXT	3,1,1	0.0	0.0->75.0	0.0	75.0	<input checked="" type="checkbox"/>

測定極点図

DS=1.0deg

49,400counts

110,046counts

13,160counts

4,338counts

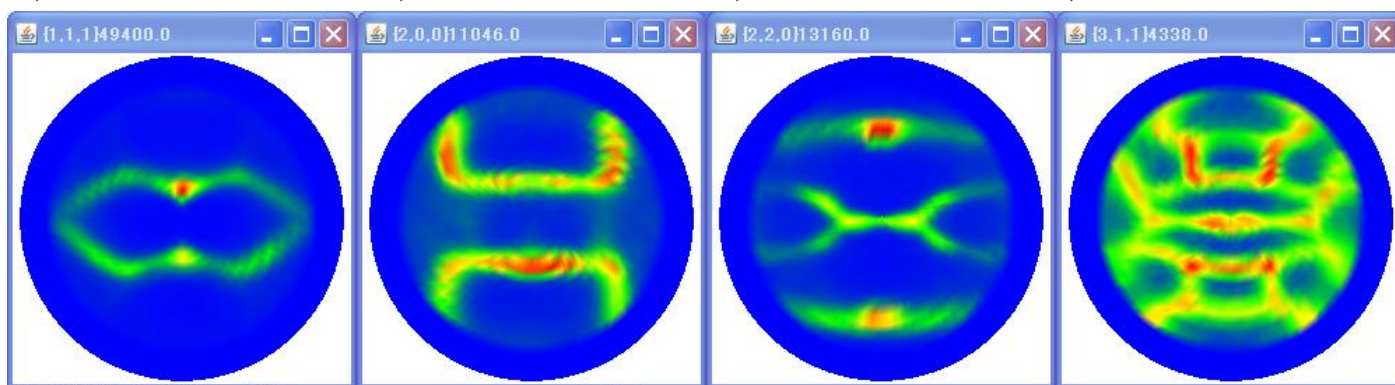

DS=1/2deg

24,948counts

5,324countc

6,670counts

2,290countc

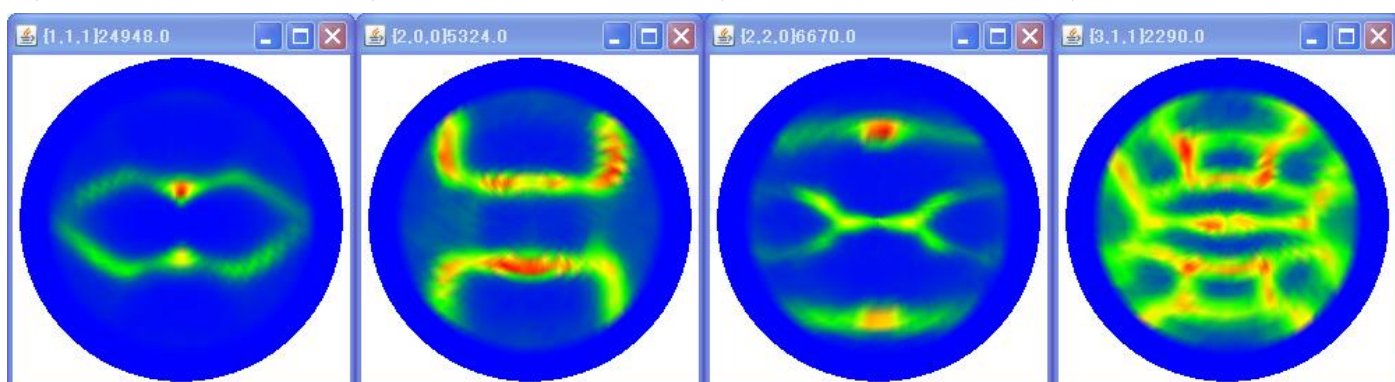

DS=1/4deg

10,754counts

3,012counts

3,546counts

1,166counts

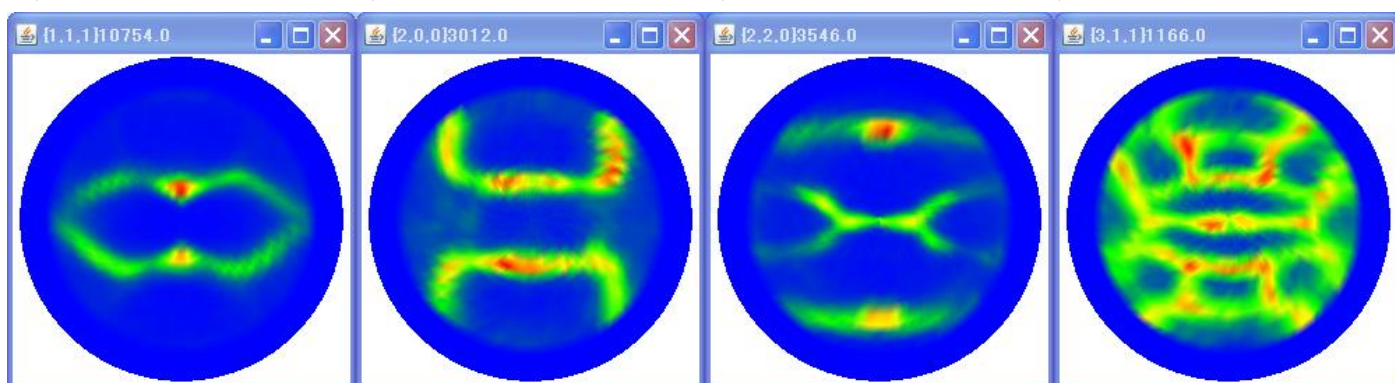

DS=1/6deg

6,460counts

2,014counts

2,034counts

762countc

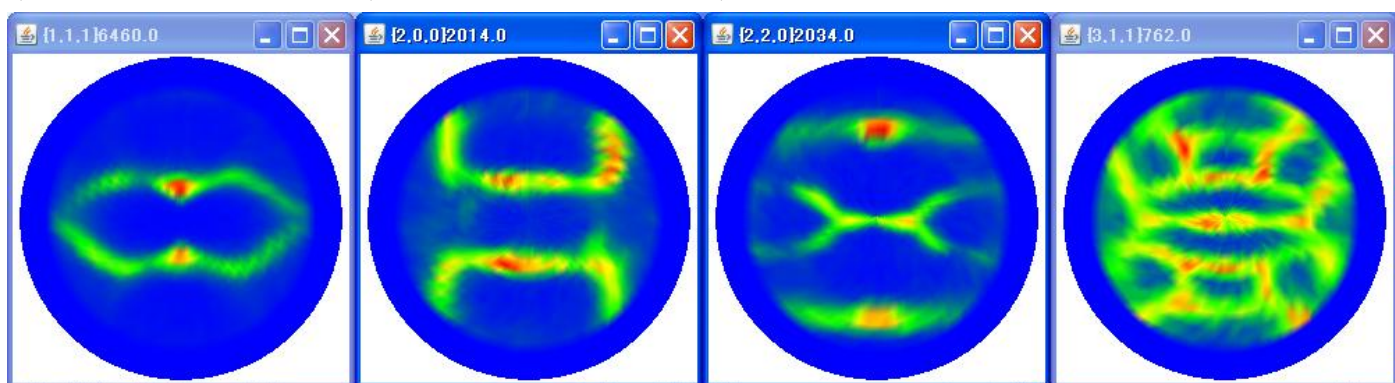

DS=1/9deg

3,964counts

1,274counts

1,354counts

606counts

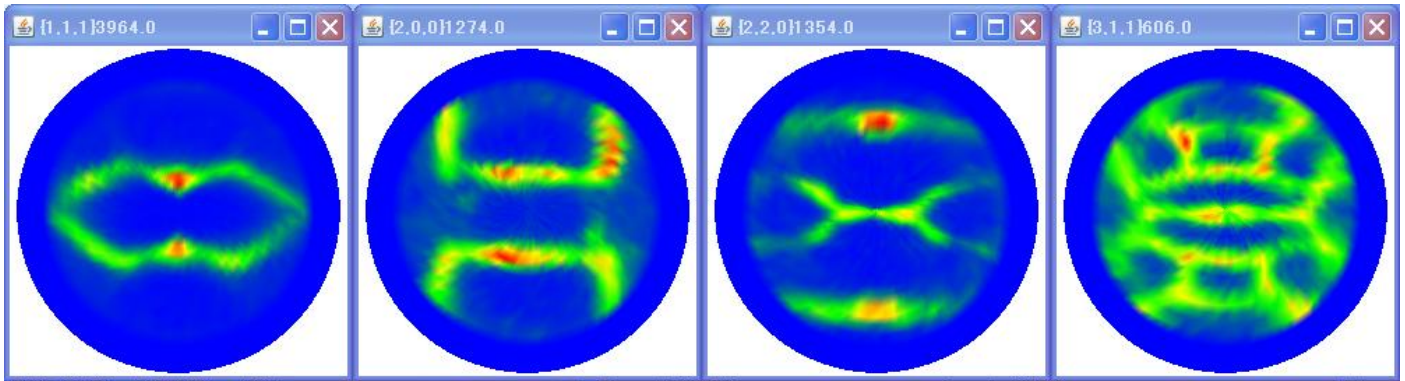

DS=1/12deg

3,032counts

1,072counts

1,044counts

340counts

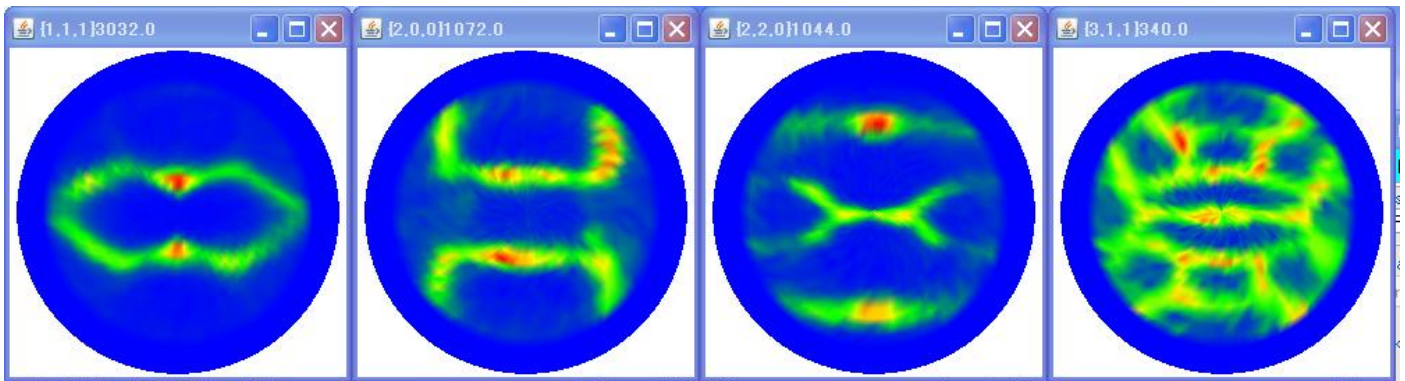

DS=1/15deg

2,448counts

816counts

832counts

334counts

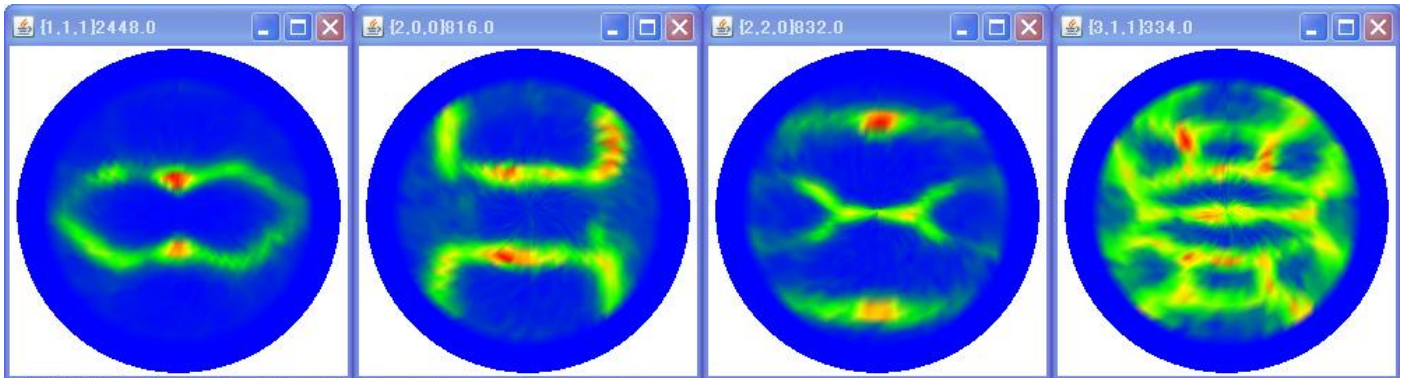

DS=1/18deg

1,982counts

692counts

682counts

284counts

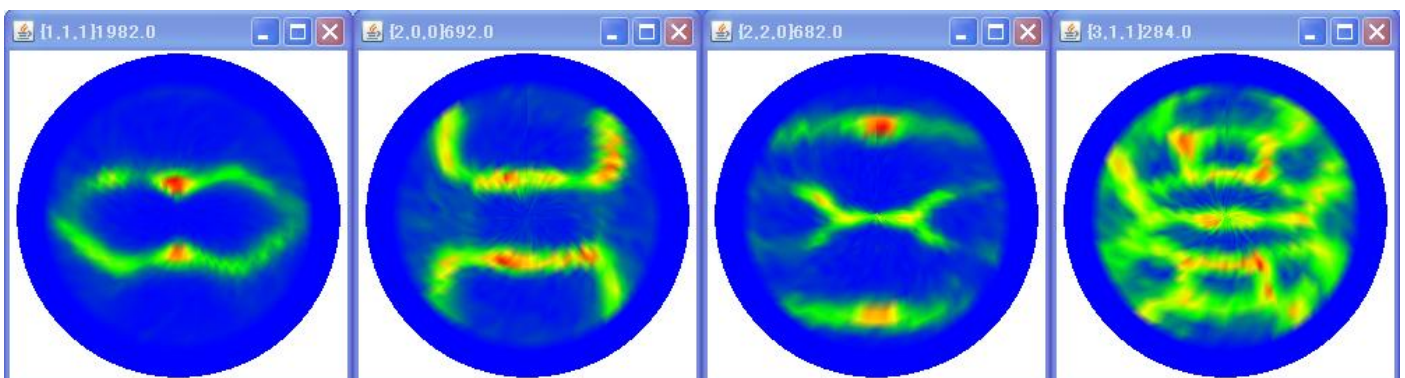

DS=1/21deg

1,556counts

500counts

574counts

214counts

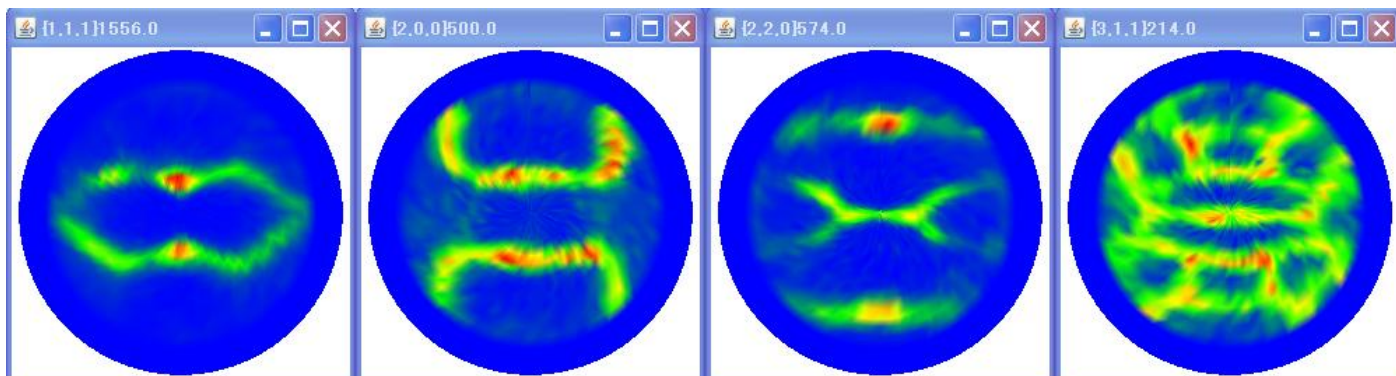

データ処理 (バックグラウンド除去、defocus 補正、SM-1-5)

DS=1.0deg

Max=12.54

5.21

9.14

3.03

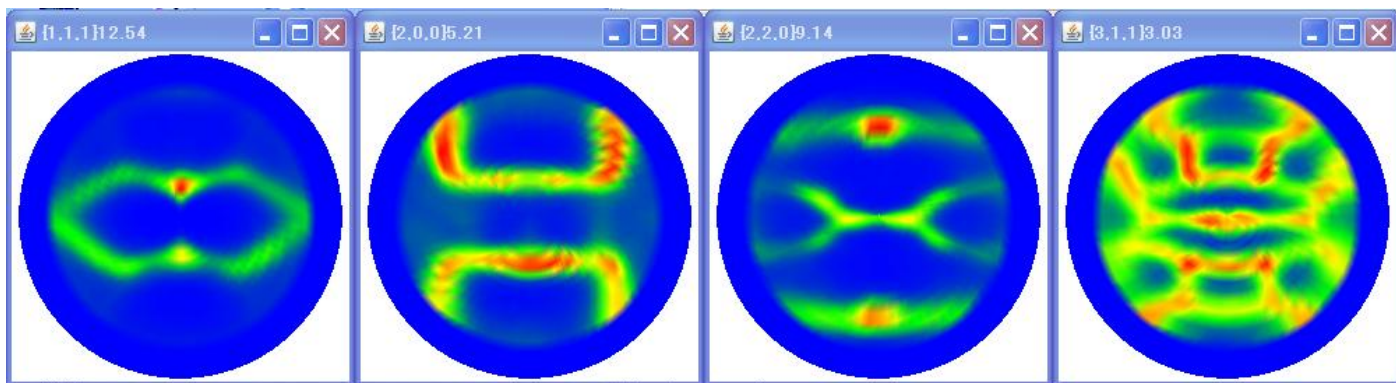

DS=1/2deg

Max=12.83

5.38

8.98

3.16

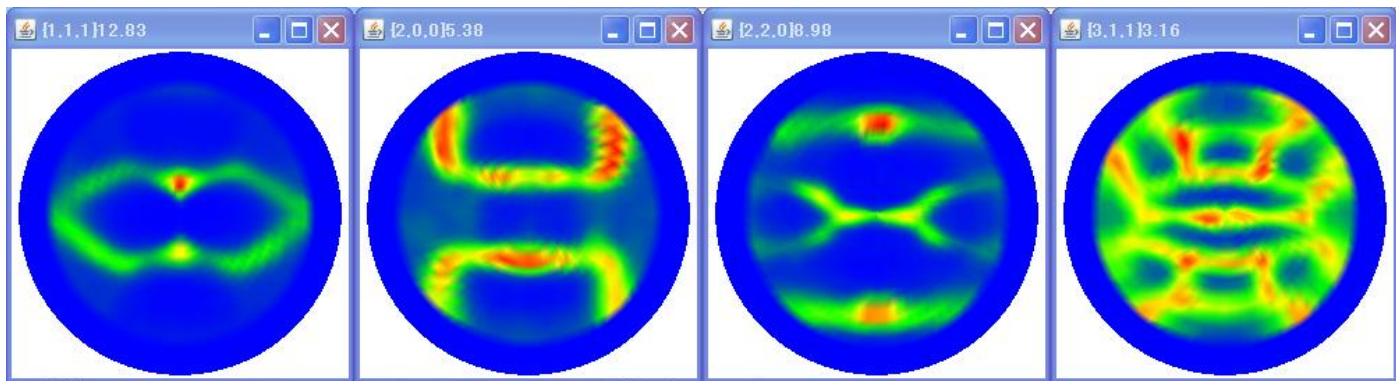

DS=1/4deg

Max=11.11

5.74

9.27

3.18

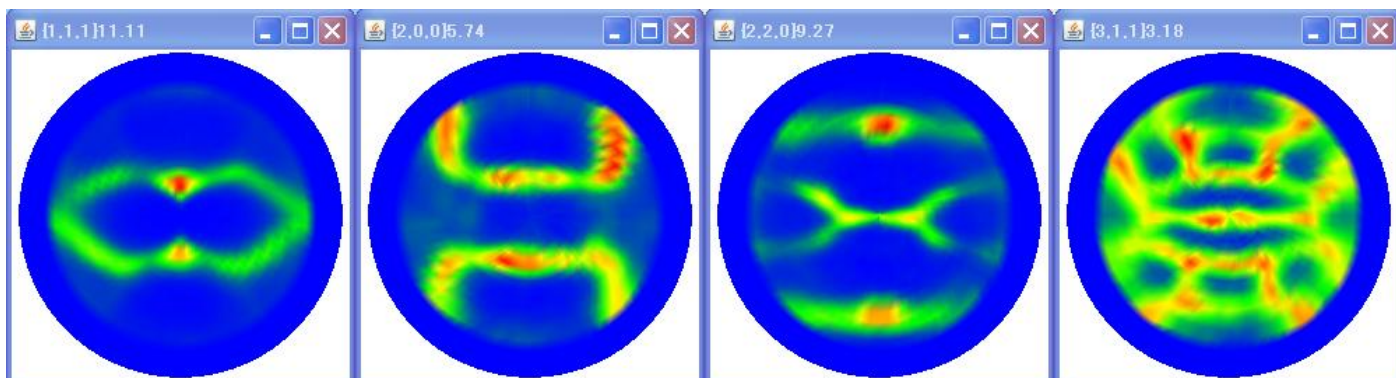

DS=1/6deg

Max=10.33

5.66

8.48

3.21

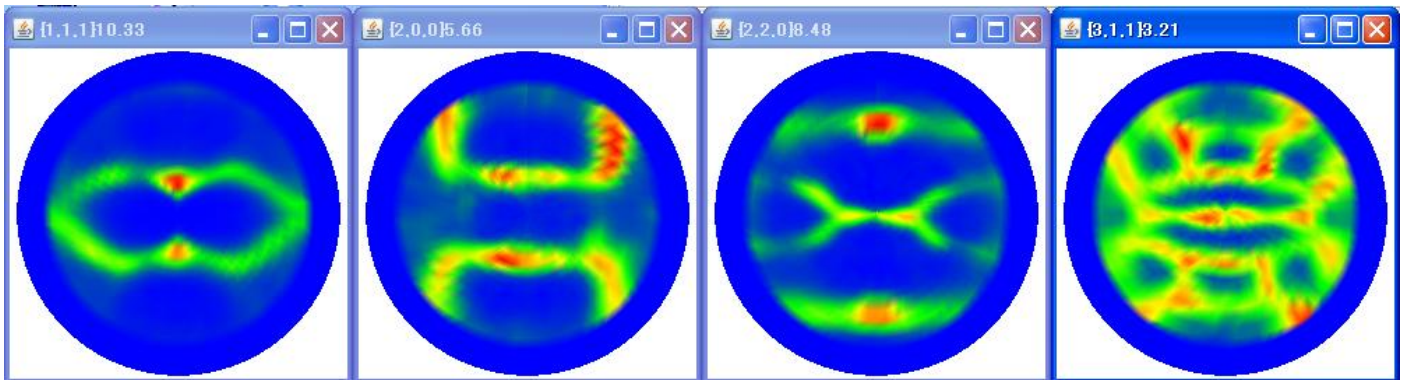

DS=1/9deg

Max=9.54

5.92

8.83

3.78

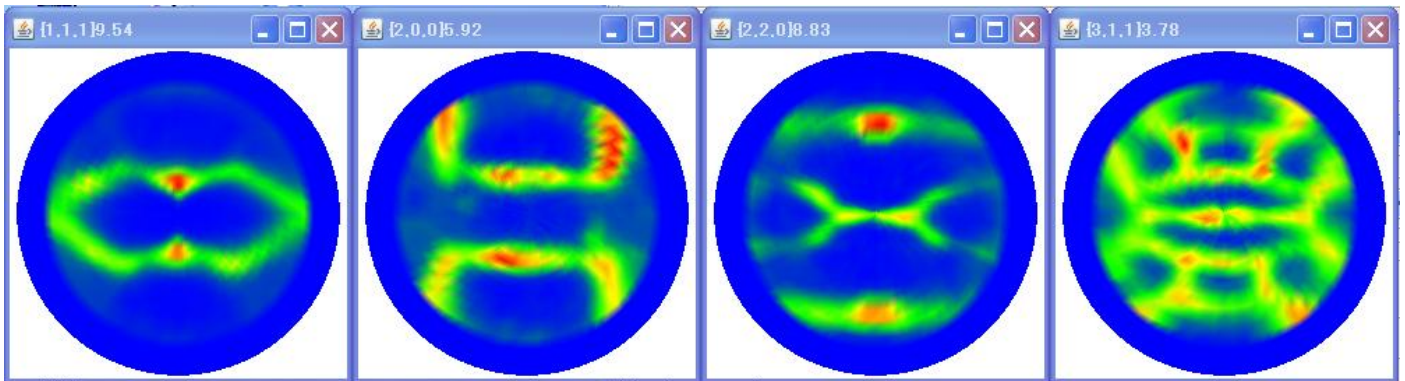

DS=1/12deg

Max=9.37

6.00

8.58

3.57

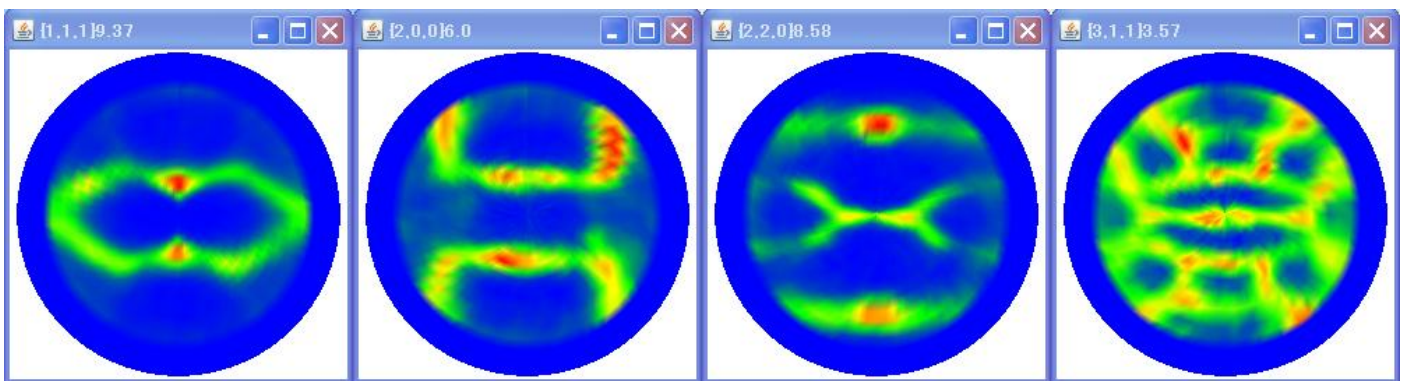

DS=1/15deg

Max=10.31

5.94

8.81

3.64

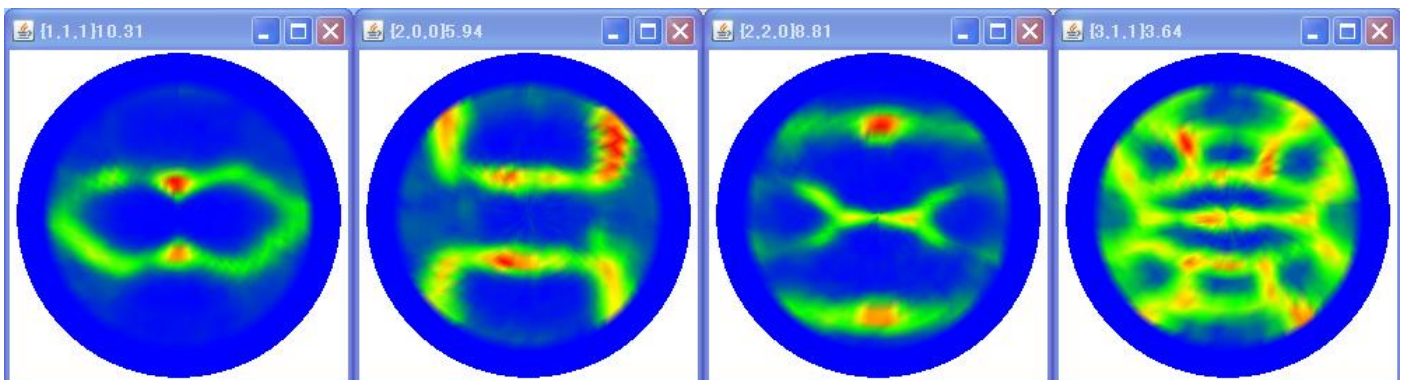

DS=1/18deg

Max=10.06

5.83

8.59

3.48

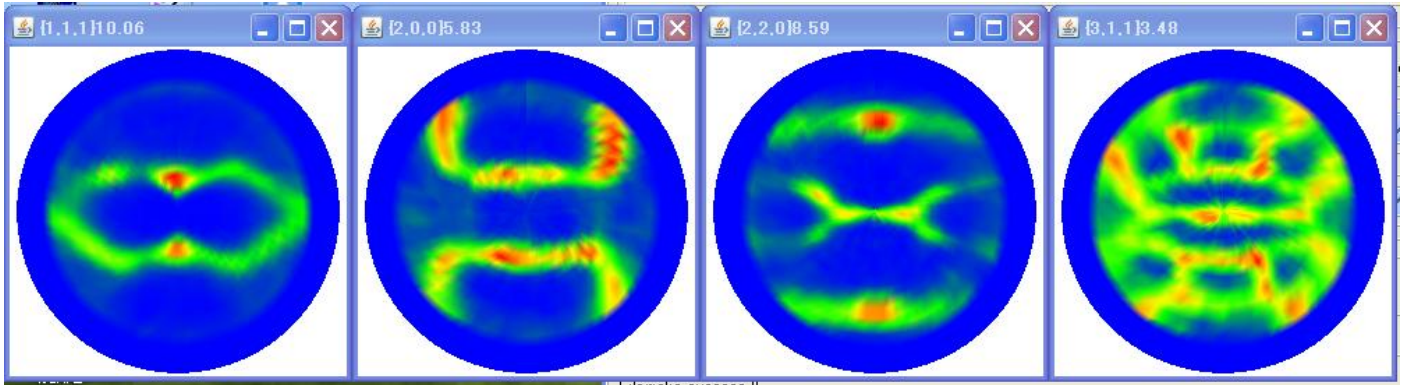

DS=1/21deg

Max=10.07

5.60

8.99

3.57

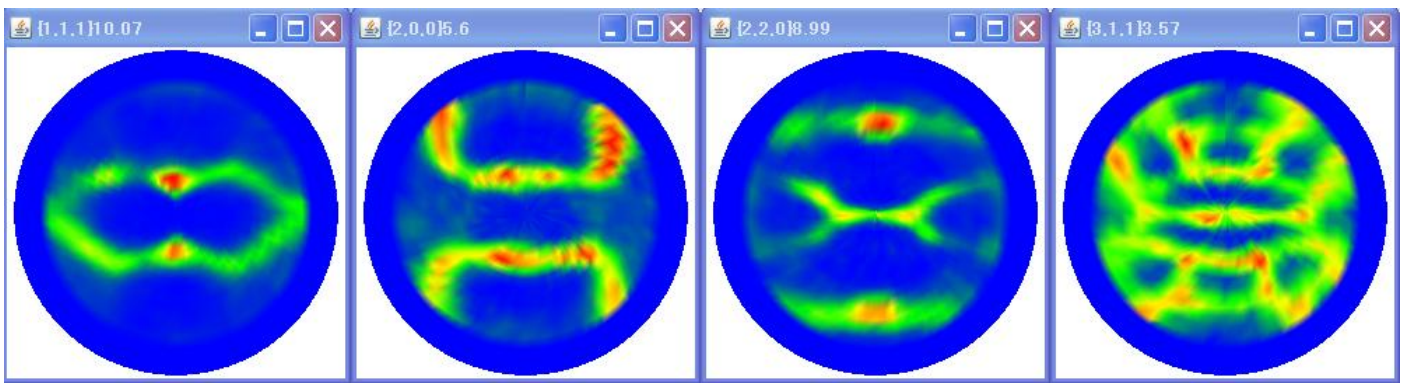

DS=1.0deg

MaxODF Euler Angle F1=30.0 F=60.0 F2=15.0

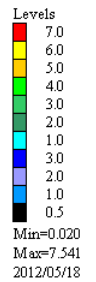
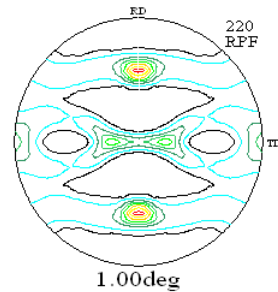
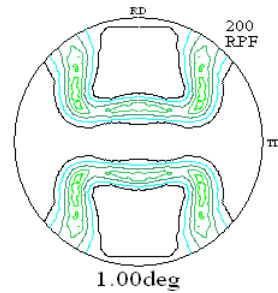
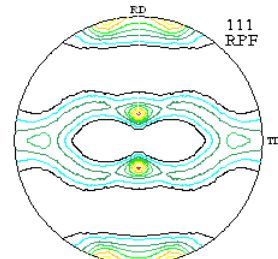
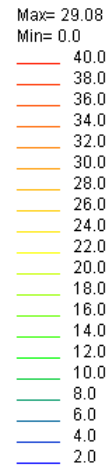
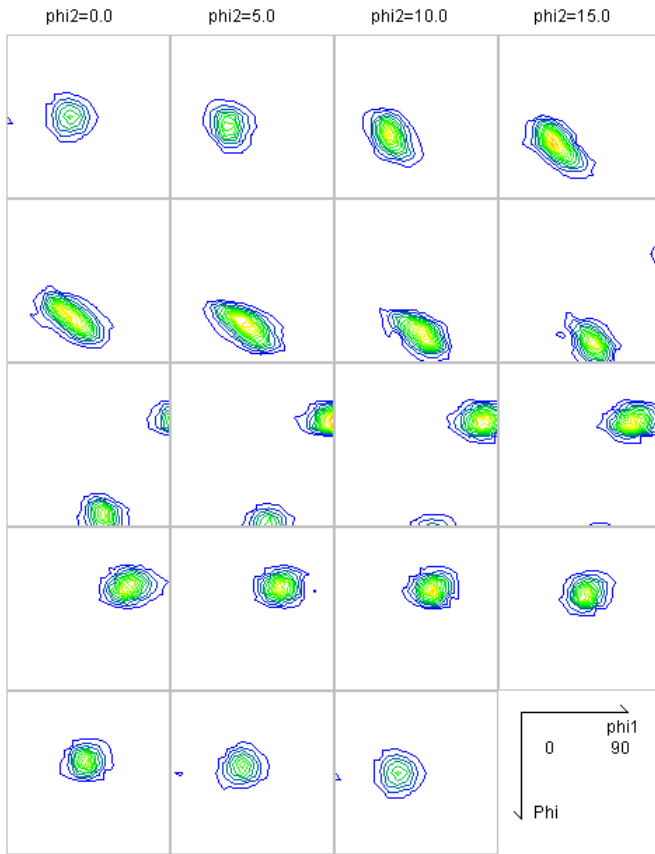

DS=1/2deg

MaxODF Euler Angle F1=30.0 F=60.0 F2=15.0

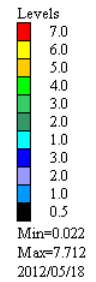
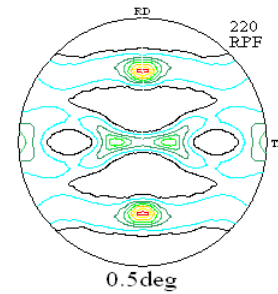
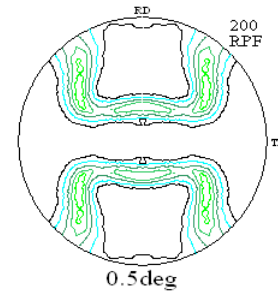
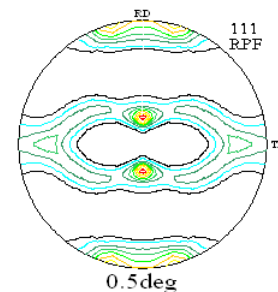
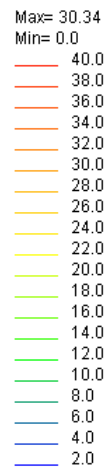
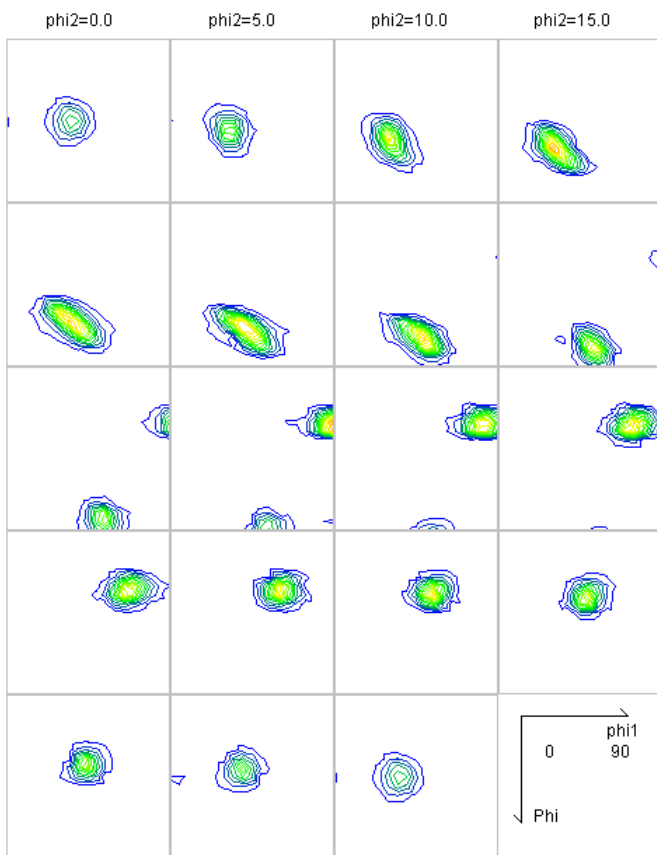

DS=1/4deg

MaxODF Euler Angle F1=30.0 F=60.0 F2=15.0

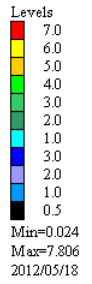
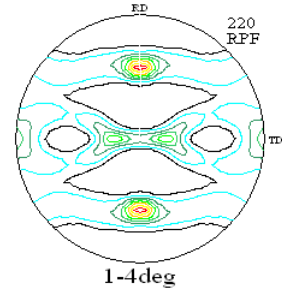
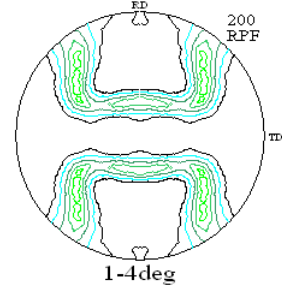
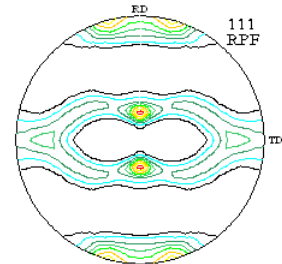
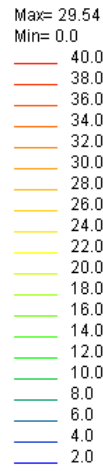
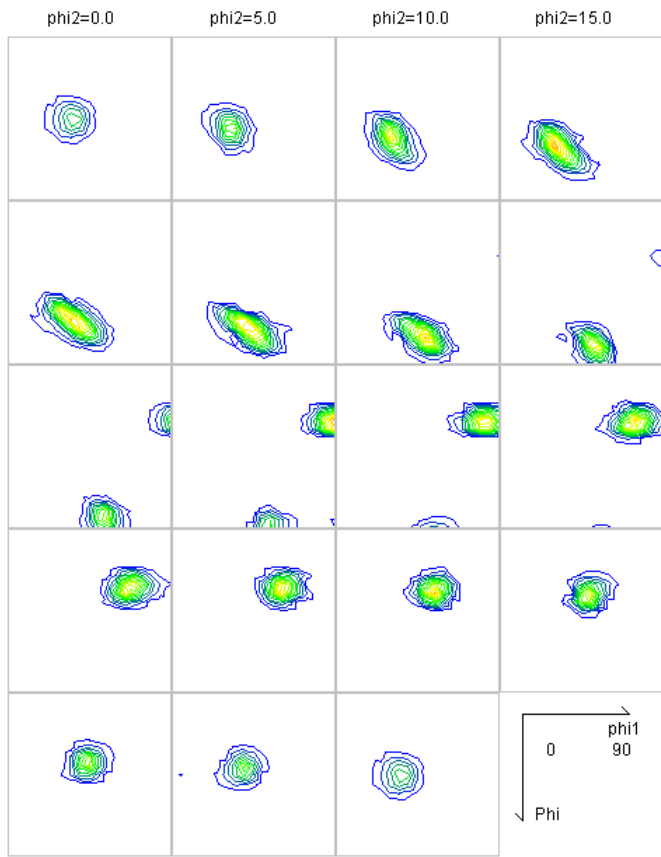

DS=1/6deg

MaxODF Euler Angle F1=90.0 F=30.0 F2=45.0

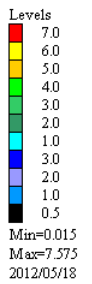
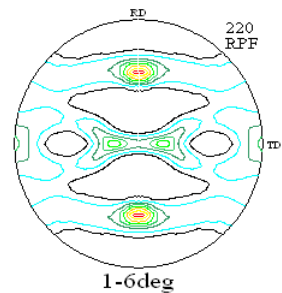
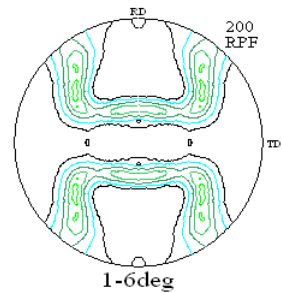
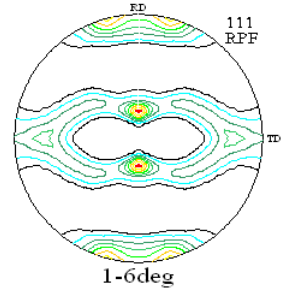
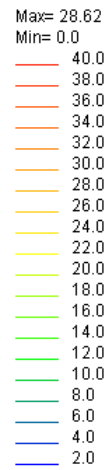
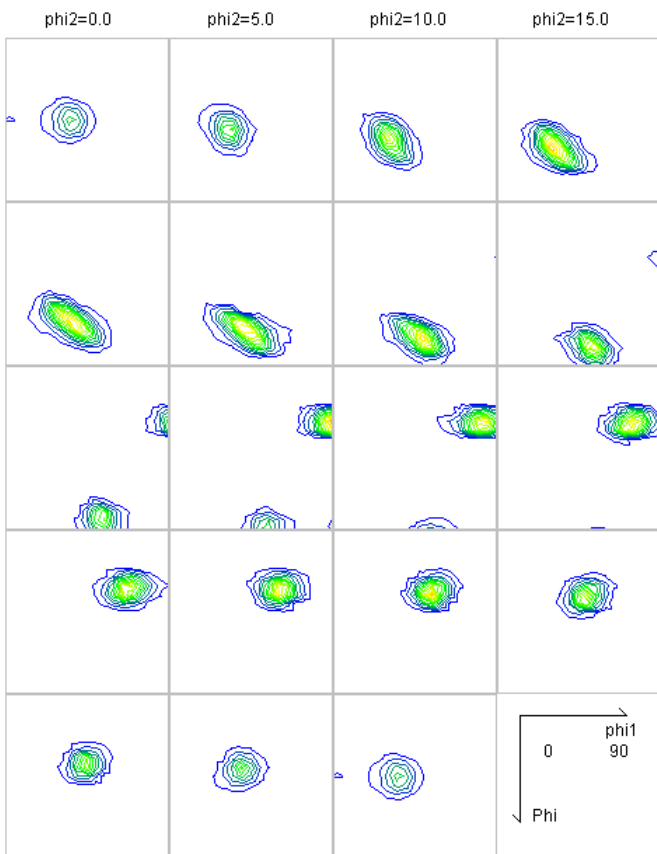

DS=1/9deg

MaxODF Euler Angle F1=90.0 F=30.0 F2=45.0

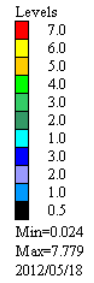
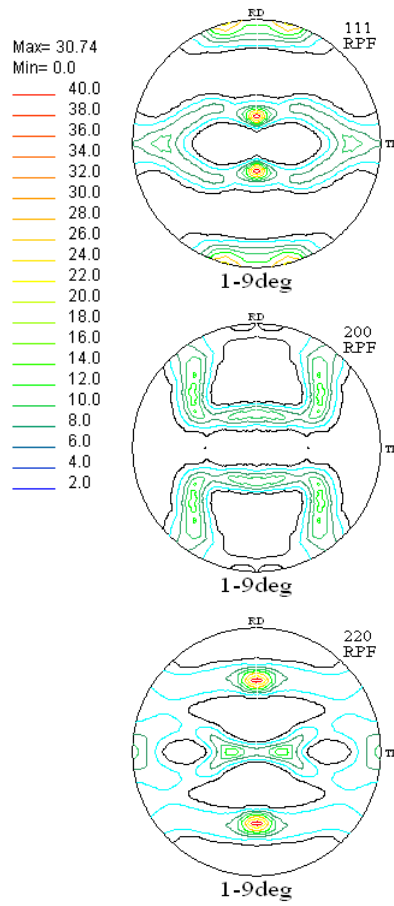
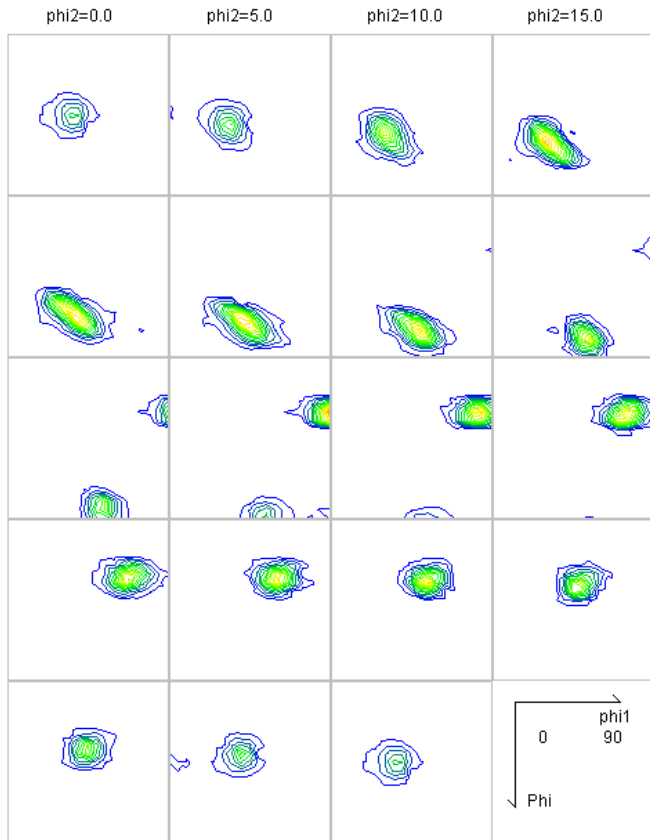

DS=1/12deg

MaxODF Euler Angle F1=90.0 F=30.0 F2=45.0

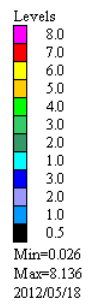
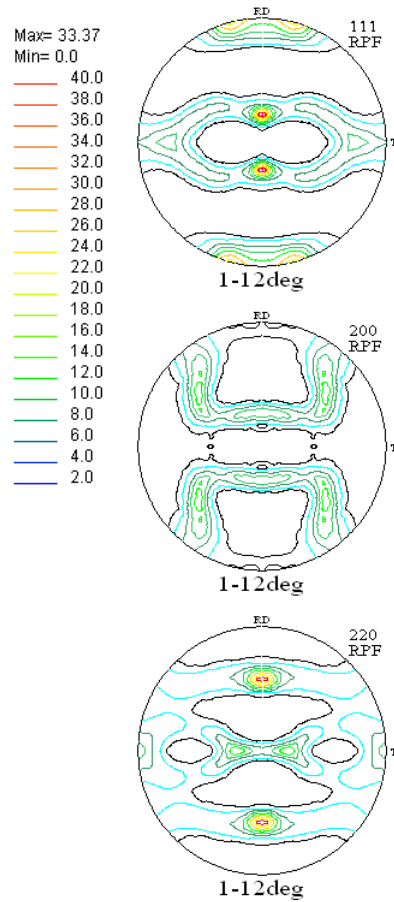
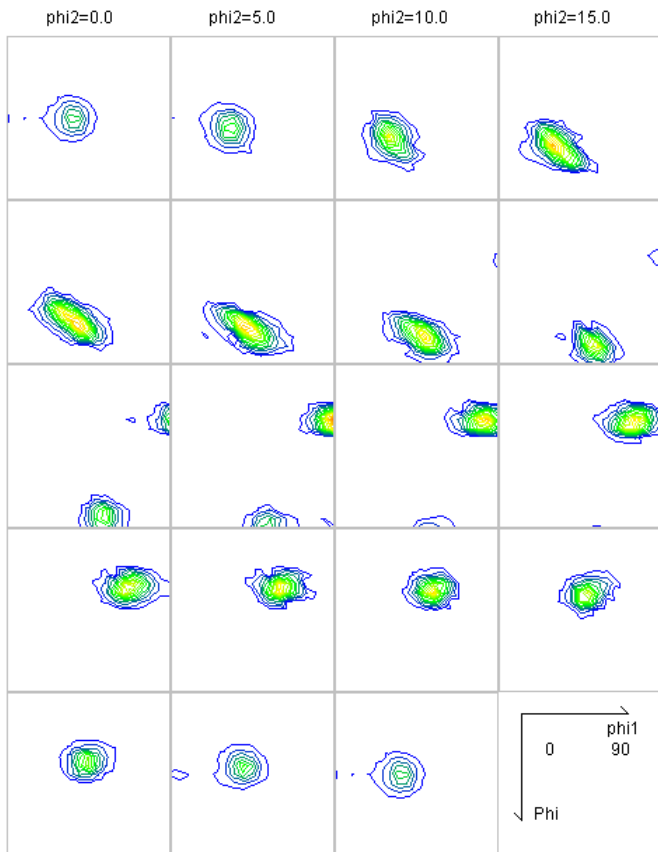

DS=1/15deg

MaxODF Euler Angle F1=30.0 F=60.0 F2=15.0

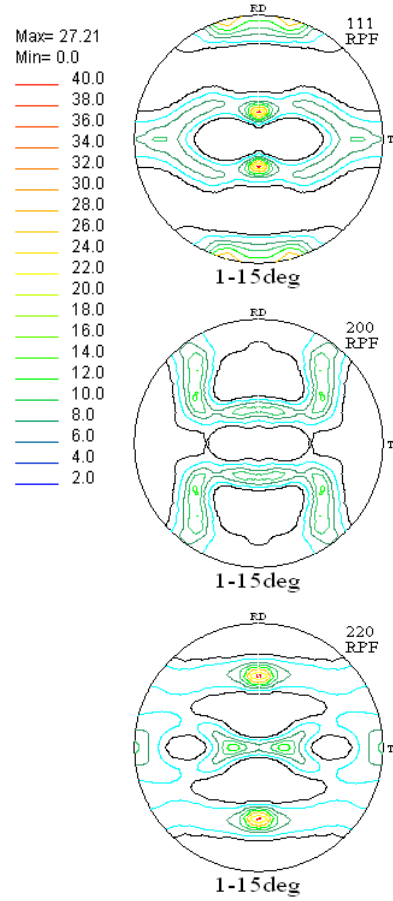
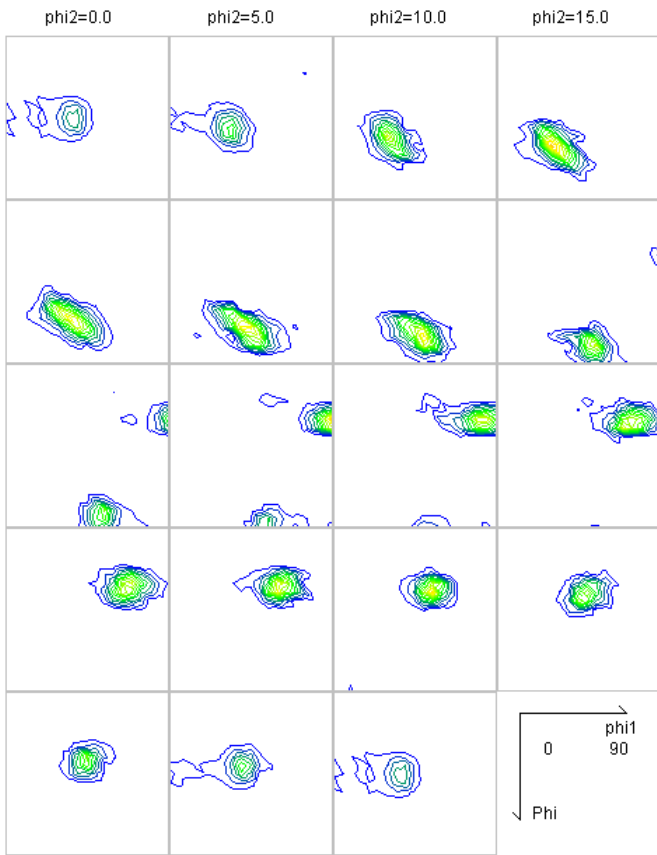

DS=1/18deg

MaxODF Euler Angle F1=30.0 F=60.0 F2=15.0

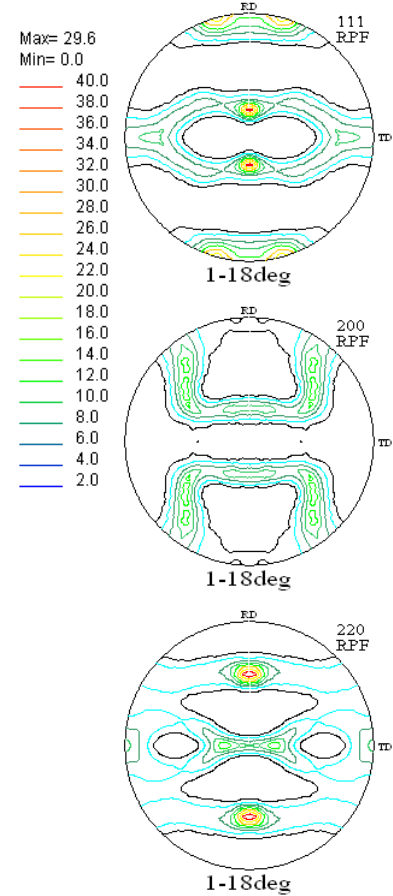
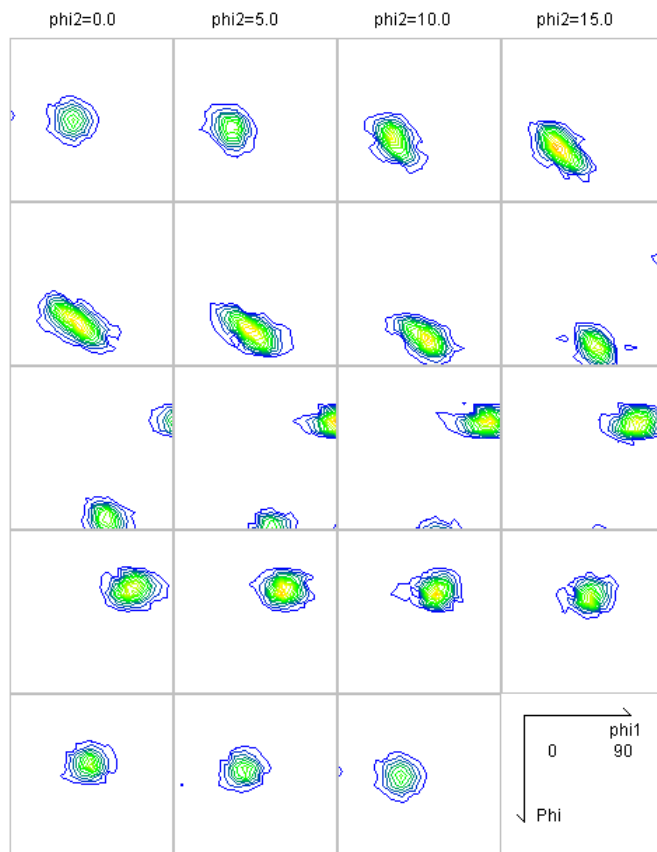

DS=1/21deg

MaxODF Euler Angle F1=30.0 F=60.0 F2=15.0

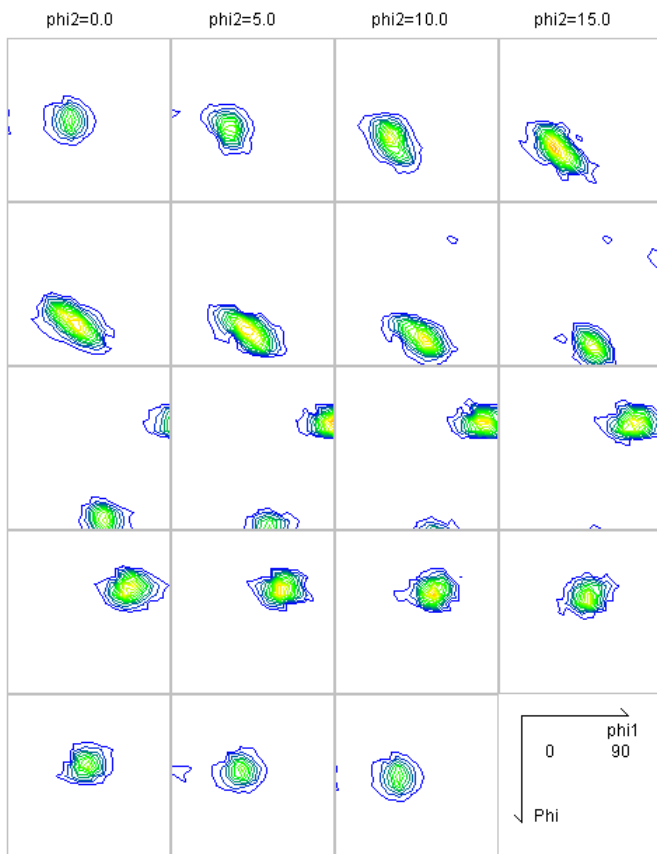

Max= 29.86
Min= 0.0

- 40.0
- 38.0
- 36.0
- 34.0
- 32.0
- 30.0
- 28.0
- 26.0
- 24.0
- 22.0
- 20.0
- 18.0
- 16.0
- 14.0
- 12.0
- 10.0
- 8.0
- 6.0
- 4.0
- 2.0

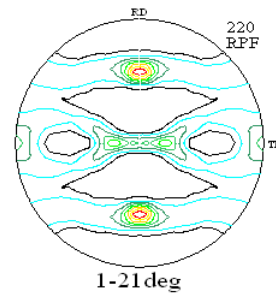
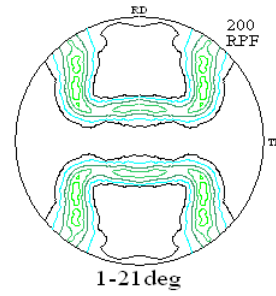
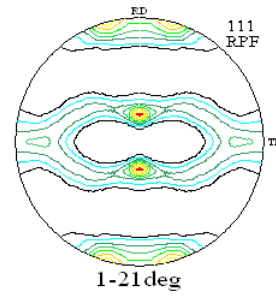

Levels

- 7.0
- 6.0
- 5.0
- 4.0
- 3.0
- 2.0
- 1.0
- 3.0
- 2.0
- 1.0
- 0.5

Min=0.016
Max=8.417
2012/05/18

DS=1.0degVF

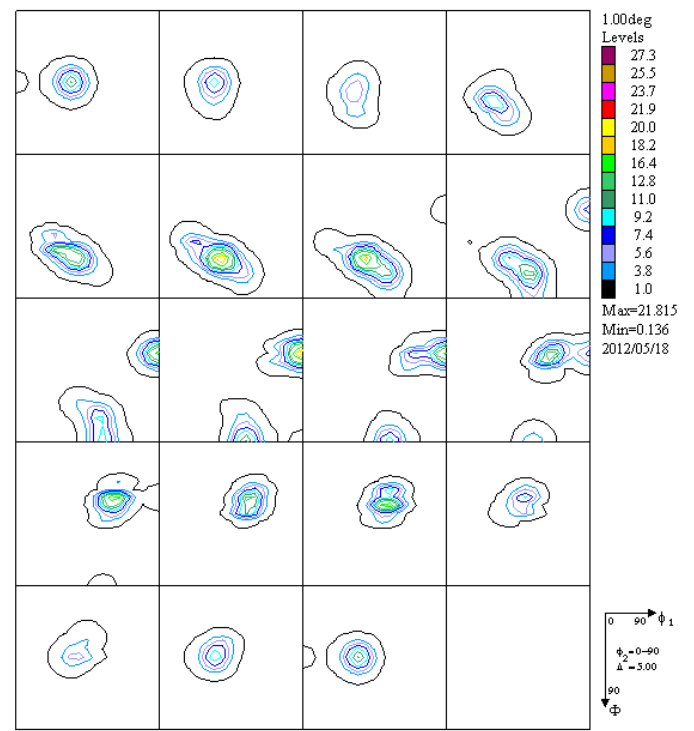
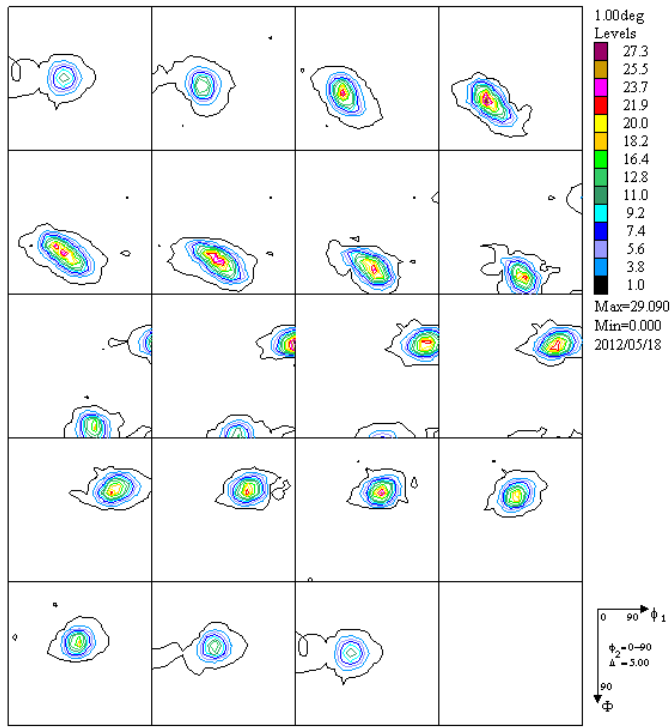

DS=1/2degVF

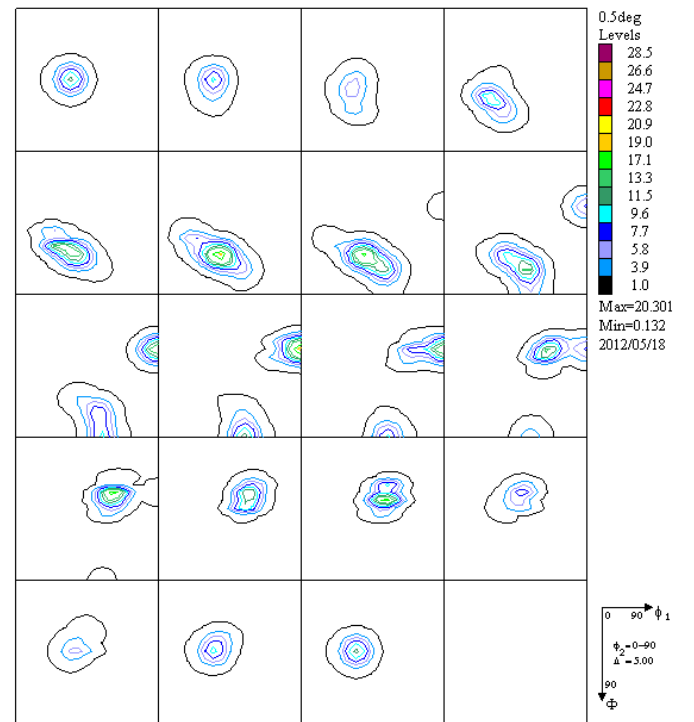
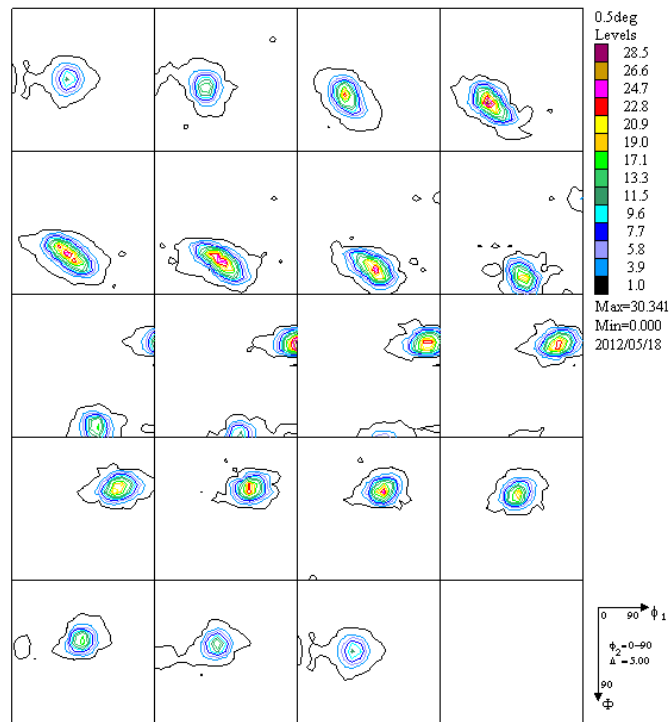

DS=1/4deg

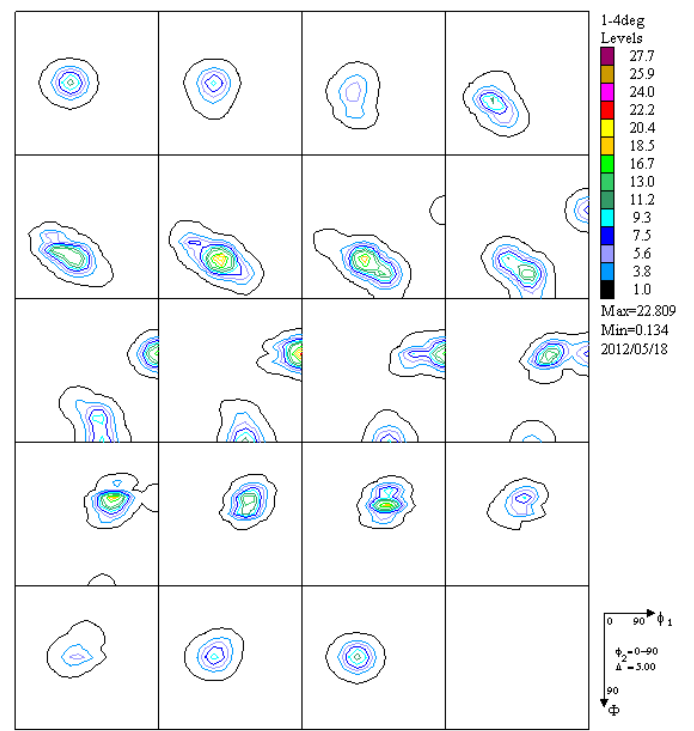
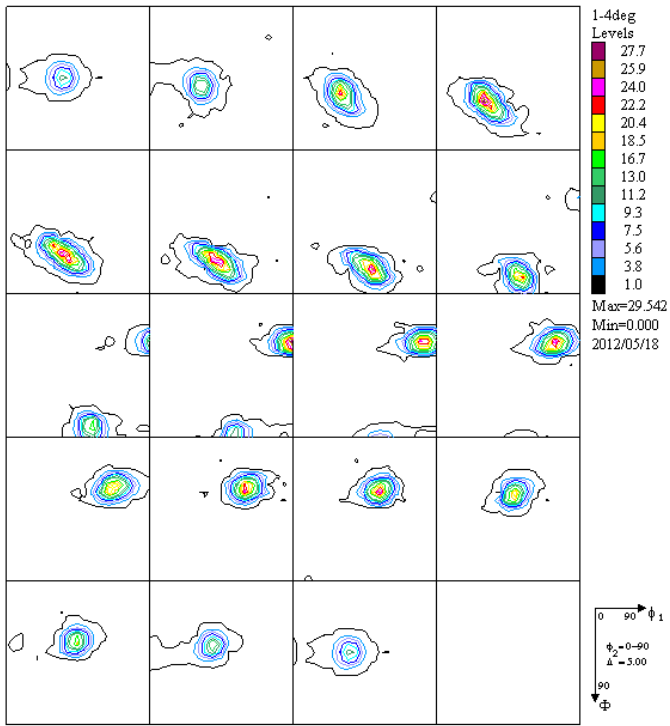

DS=1/6deg

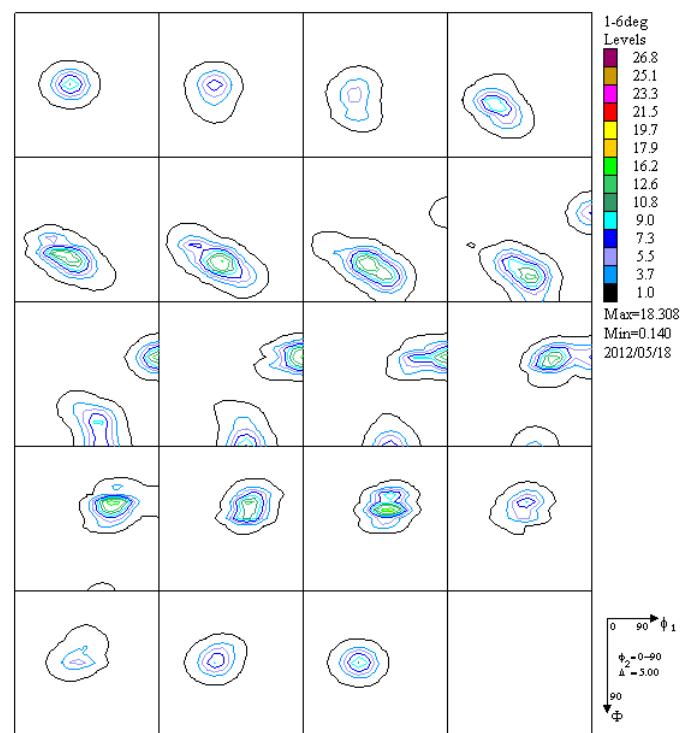
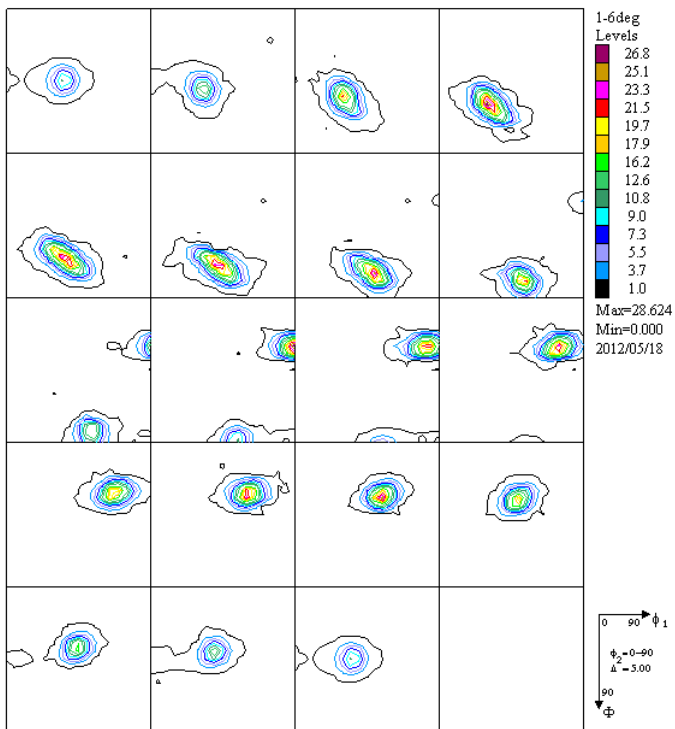

FDS=1/9deg

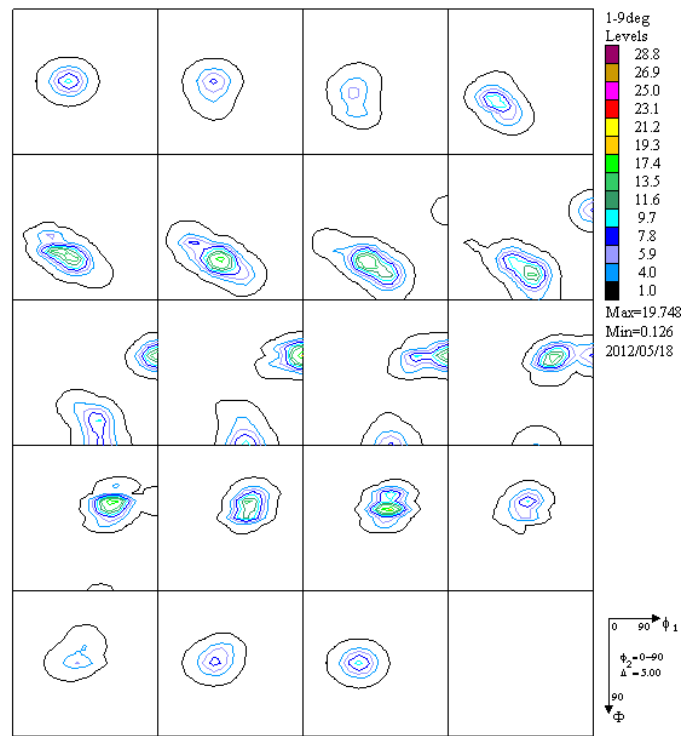
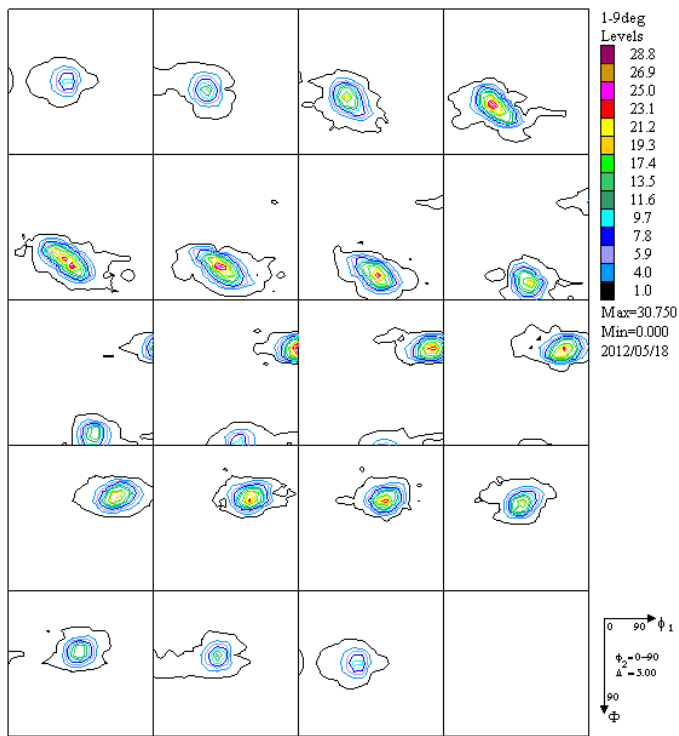

DS=1/12deg

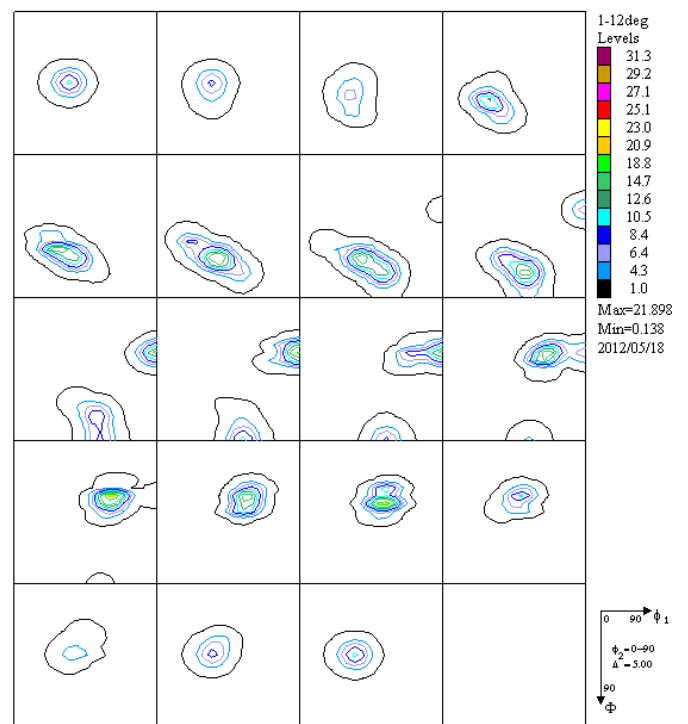
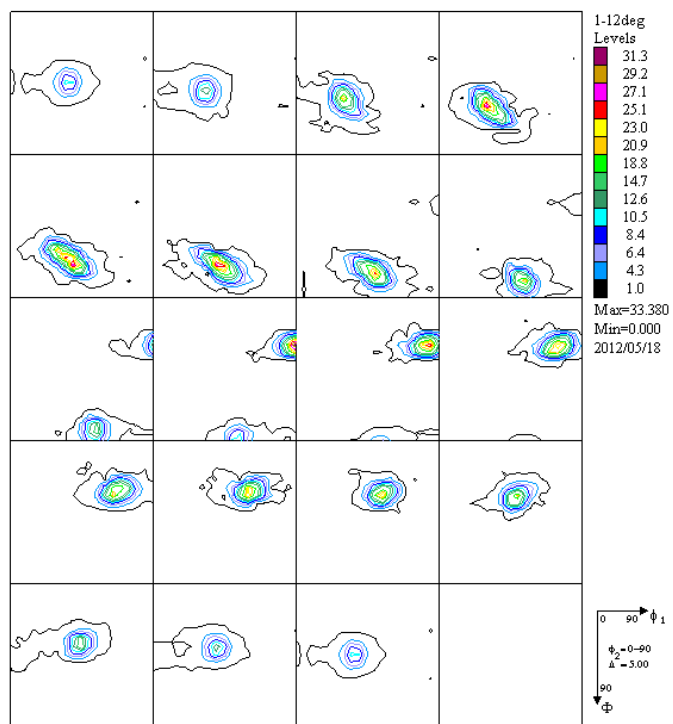

DS=1/15deg

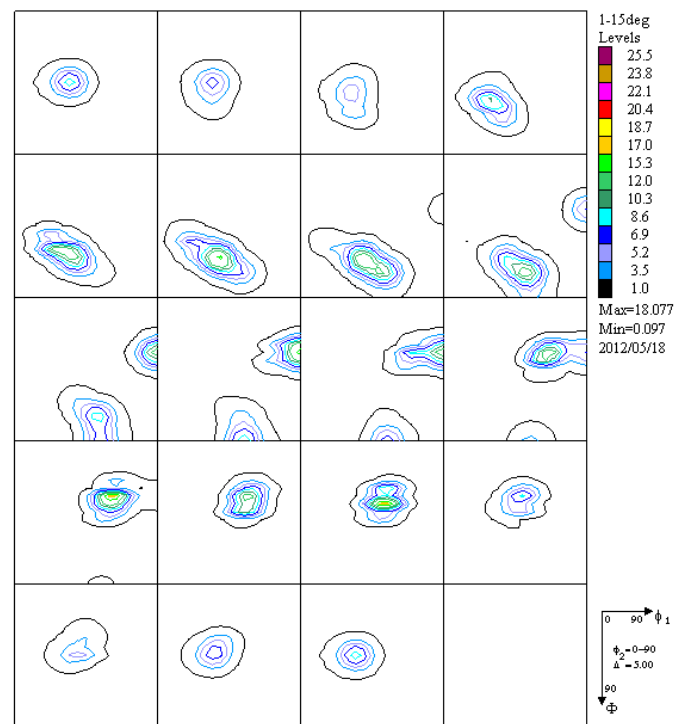
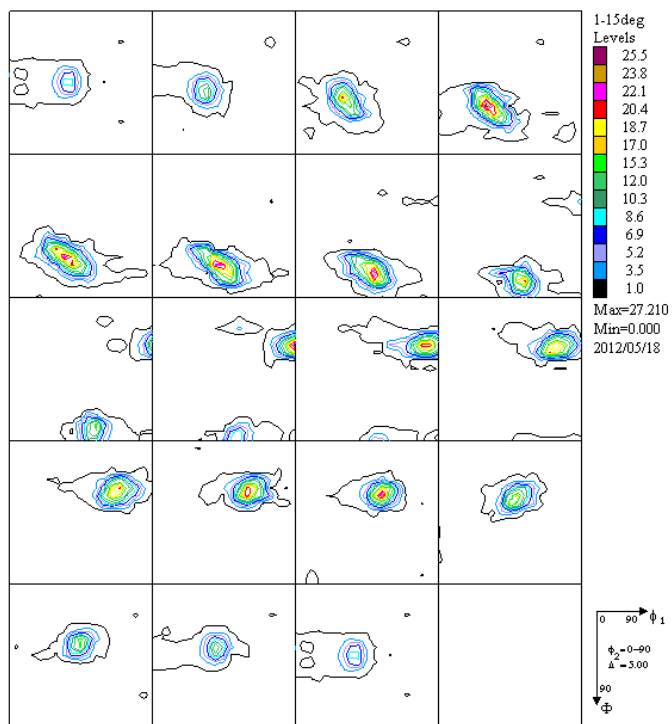

DS=1/18deg

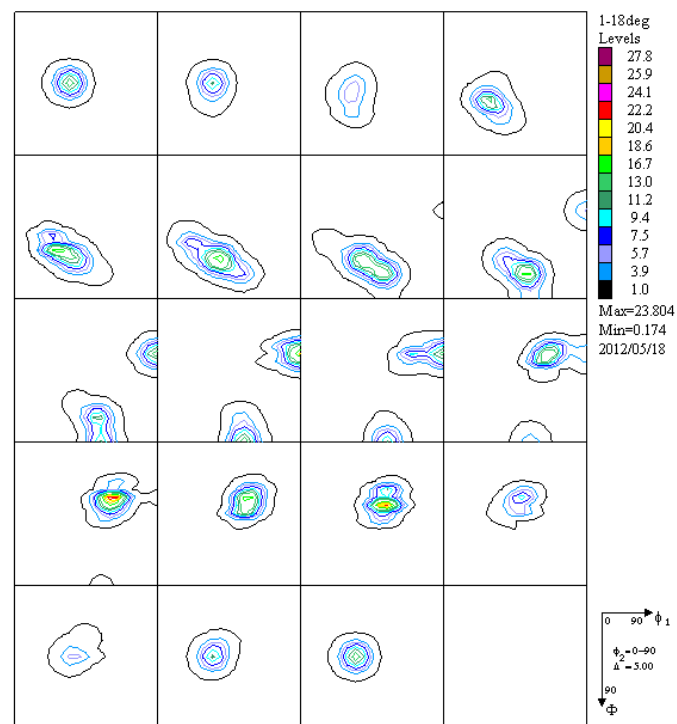
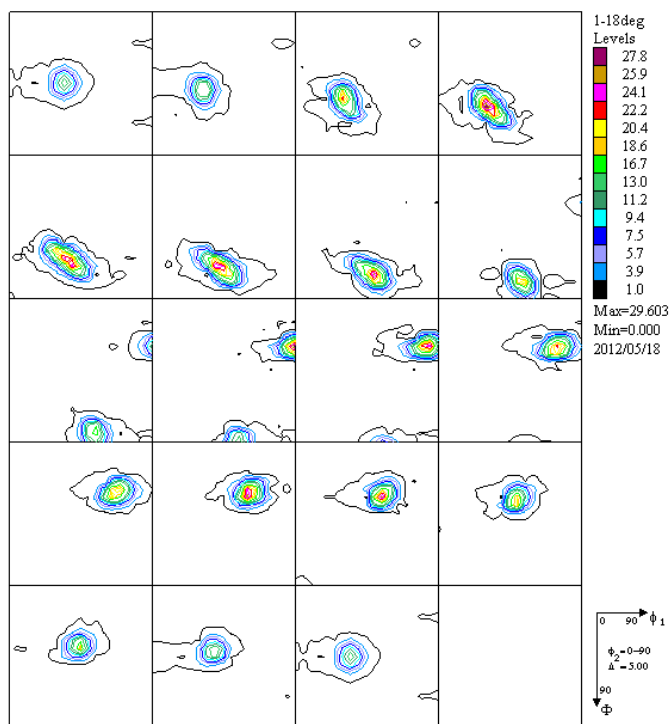

DS=1/21deg

